

INSTRUCTIONS

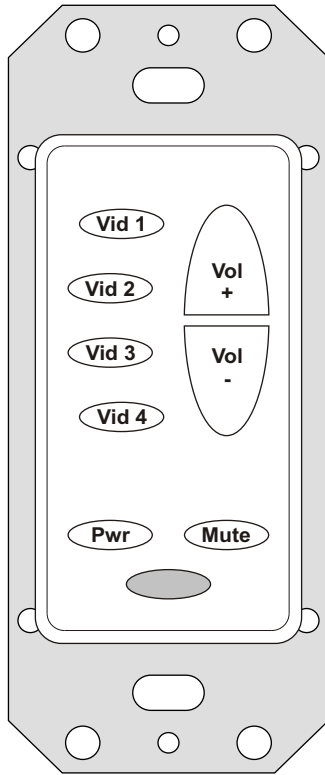

A0127

IR Keypad for Multi-Room Audio Systems

A0127 Keypad

A0127 ... Keypad controller for use with the A4603, A4623, WA-350, and A0350.

Features:

Available in both white (A0127W) and ivory/almond (A0127IA) colors.

User changeable source buttons make it easy to customize.

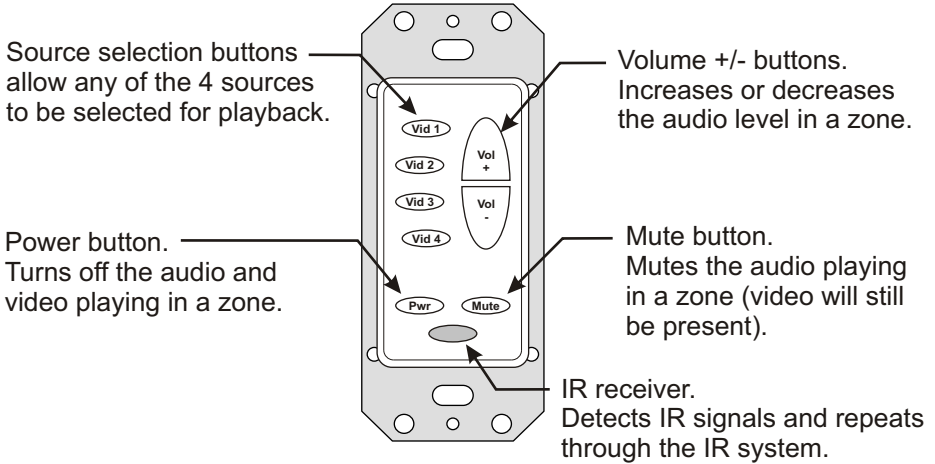

How IR repeating works

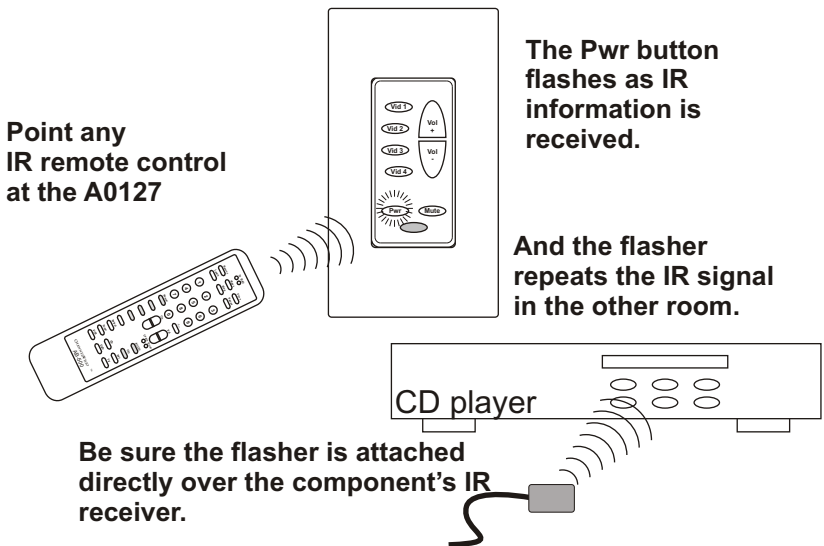

Changing buttons face plates on the A0127 keypad...

The A0127IA comes with both Almond and Ivory face plates and buttons. Both the A0127W and A0127IA come with replacement buttons labeled for a variety of sources.

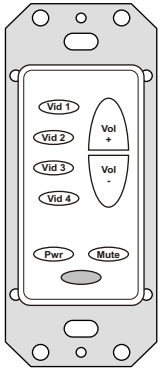

The procedure below describes the how to exchange your buttons and faceplate.

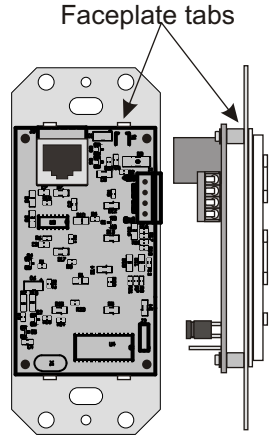
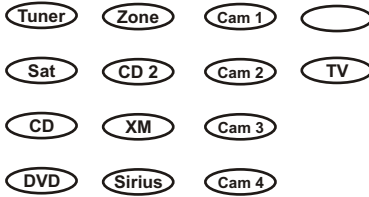

1 Detach the existing faceplate by pressing the plastic tabs with a flat blade screwdriver. (Press inward and upward ① at a 30 degree angle)

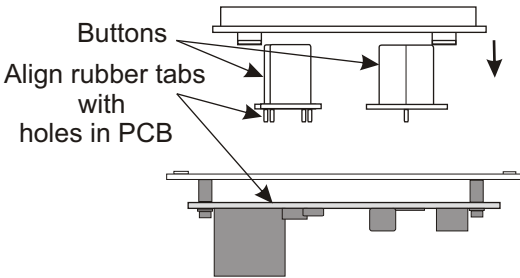
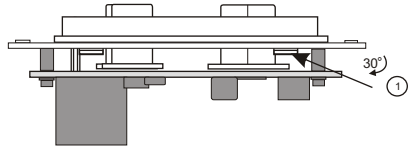

2 Exchange the labeled buttons (and colored faceplate) to your preference and assemble as shown

Accessories

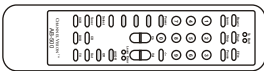

AB-500 ... Universal remote control.. Learns IR codes for up to 6 sources.

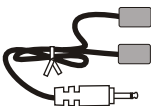

IR-3003 & IR-3002 ... Single and dual head IR flashers. Use one head per source to control from the remote room. (IR-3002 shown).

ear Panel

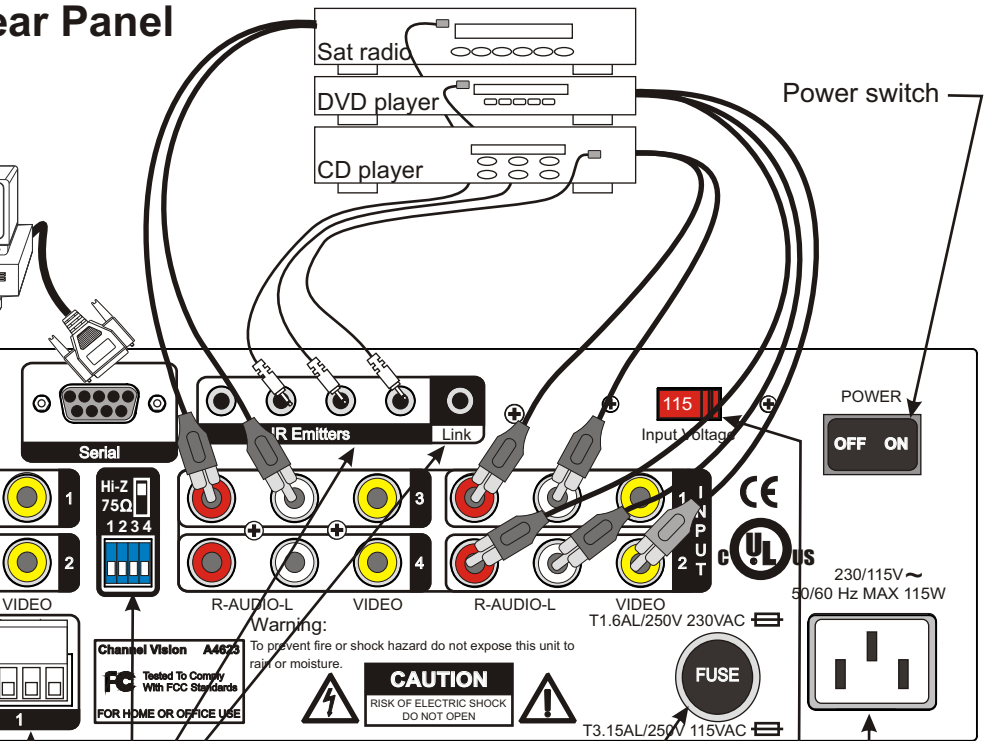

Main Power Fuse

IR Link allows two A4623 units to be joined so that IR signals picked up by the keypads of the first unit can be shared to the second unit. The IR-4180 cable can be used to link two units together.

IR emitter outputs allow IR-3002 flashers to be connected for remote control of source components.

Switch for 110-120V or 220-240V operation

Main Power Input connection

When splitting the video signal from a source component, use the dip switch to enable the Hi-Z mode on that input.

Removable screw terminals for speaker wires provide an excellent connection and allow speaker wires to be connected and disconnected very quickly.

Wiring the A0127 keypad...

Keypads connect to the A4603/A4623 through the RJ45 jacks on the back panel of the A4603/A4623. Connections to the A0127 may be accomplished either by using the RJ45 jack or the screw terminals provided on the back side of the keypad. When using the RJ45 jacks, simply wire both ends of the cable according to the TIA568A standard. When using the screw terminals on the A0127, make sure to wire the RJ45 plug connecting to the A4603/A4623 as shown below.

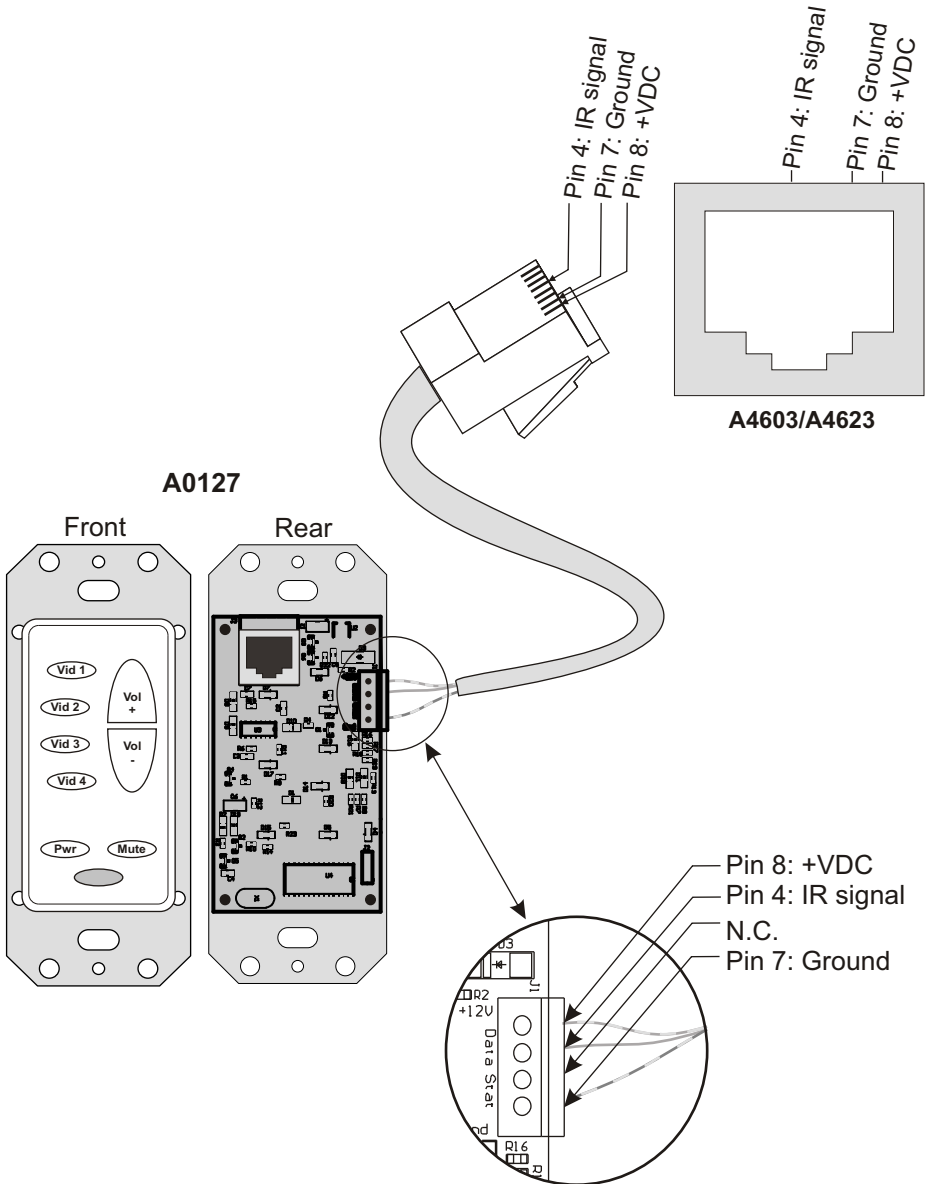

Using the A0505 remote control.. designed to control many Channel Vision products. (Download IR codes at: www.channelvision.com)

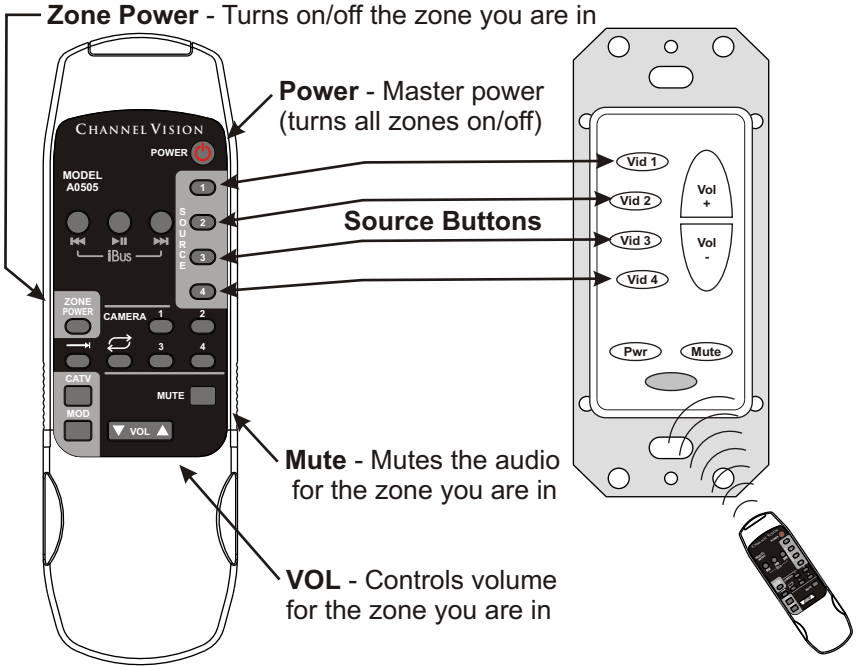

Setting the A0127 as the master keypad...

By changing a jumper setting on the A0127 you can make it a master keypad. This simply means that the master A0127 will be able to power on or power off the entire system from a single zone.

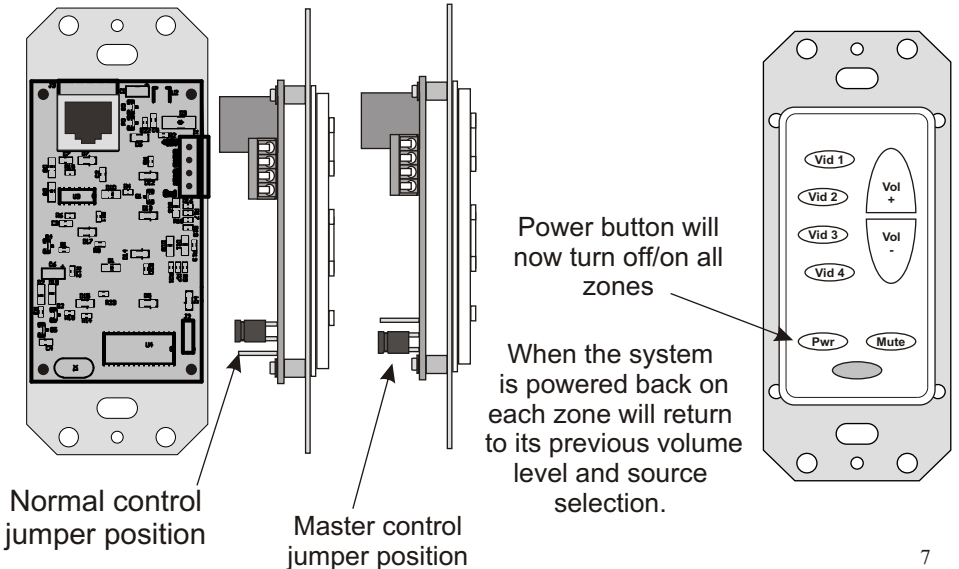

CHANNEL VISION™

1 Year Limited Warranty

Channel Vision Technology will repair or replace any defect in material or workmanship which occurs during normal use of this product with new or rebuilt parts, free of charge in the USA, for one year from the date of original purchase. This is a no hassle warranty with no mail in warranty card needed. This warranty does not cover damages in shipment, failures caused by other products not supplied by Channel Vision Technology, or failures due to accident, misuse, abuse, or alteration of the equipment. This warranty is extended only to the original purchaser, and a purchase receipt, invoice, or other proof of original purchase date will be required before warranty repairs are provided.

Mail in service can be obtained during the warranty period by calling (800) 840-0288 toll free. A Return Authorization number must be obtained in advance and can be marked on the outside of the shipping carton.

This warranty gives you specific legal rights and you may have other rights (which vary from state to state). If a problem with this product develops during or after the warranty period, please contact Channel Vision Technology, your dealer or any factory-authorized service center.

Channel Vision products are not intended for use in medical, lifesaving, life sustaining or critical environment applications. Channel Vision customers using or selling Channel Vision products for use in such applications do so at their own risk and agree to fully indemnify Channel Vision for any damages resulting from such improper use or sale.

 CHANNEL VISION™
channelvision.com

234 Fischer Avenue, Costa Mesa, California 92626
(714)424-6500 • (800)840-0288 • (714)424-6510 fax

500-071 revE